



www.stiga.com

Illustrated Parts List

for model:

ESTATE MASTER

- Use GLOBAL GARDEN PRODUCT genuine spare parts specified in the parts list for repair and/or replacement.
- Then contents described in the parts list may change due to improvement.
- The drawings of the spare part are only indicative and might not represent the part in question exactly.
- The indications "right" - "left" - "front" - "rear" refer to the position of the operator when using the machine.
- When placing orders of parts for repair and/or replacement, make sure that the illustrated parts list is the one applying to the machine's year of manufacture, as shown on the identification plate attached to the machine.

© Copyright 2013 Global Garden Products

All content is subject to copyright by Global Garden Products and may not be reproduced in whole or in part by any means, electronic or otherwise, without prior written approval.

THIS INFORMATION IS NOT INTENDED FOR SALE OR RESALE, AND THIS NOTICE MUST REMAIN ON ALL COPIES.

www.ggp-group.com



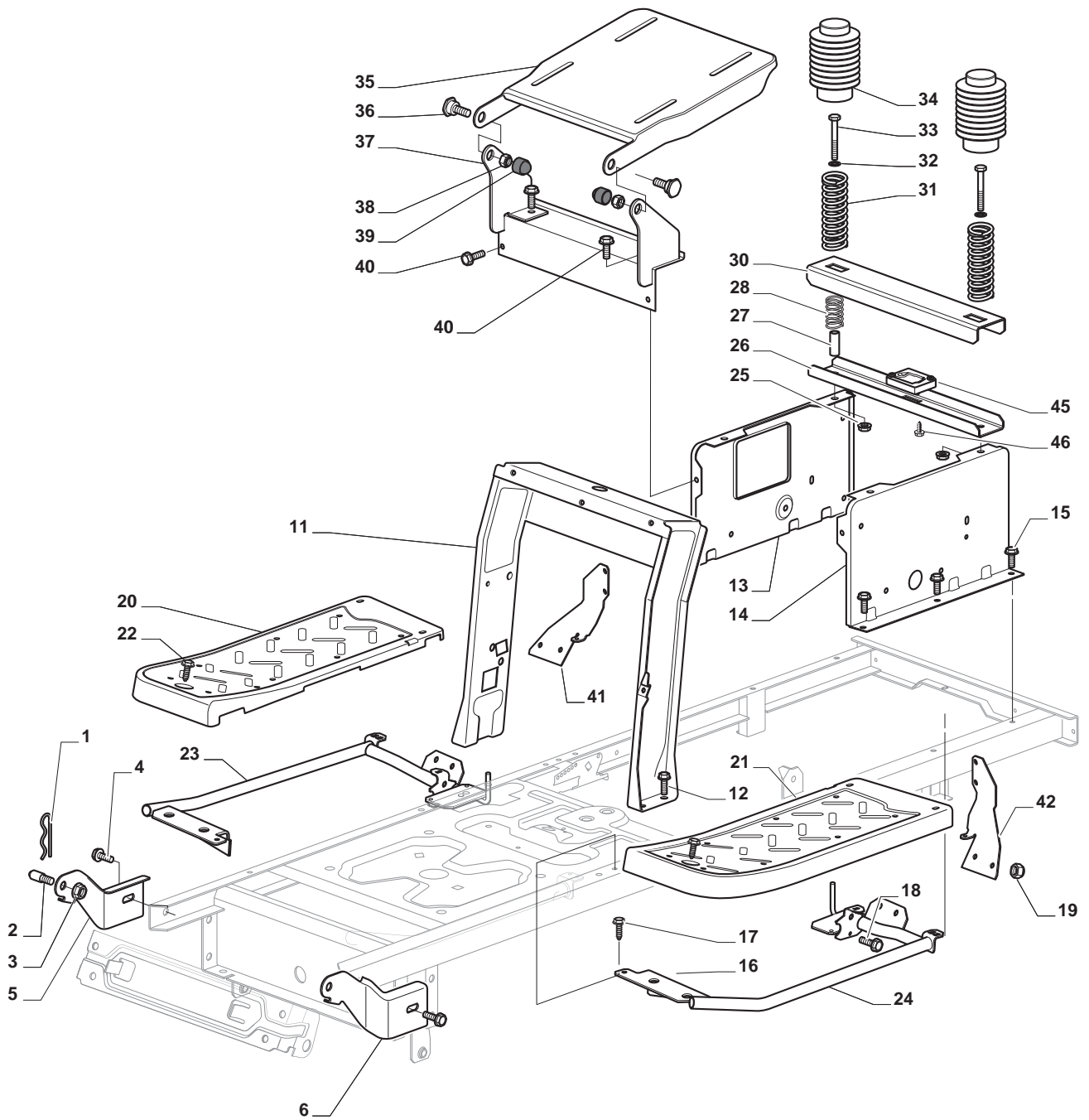

Chassis				
POS	CODE	Q.TY	DESCRIPTION	NOTES
1	124487998/0	1	Cotter Pin	
2	125510079/1	2	Pin	
3	112154210/0	2	Self-Locking Nut	
4	112735599/0	2	Screw	
5	325547225/0	1	Right Plate	
6	325547227/0	1	Left Plate	
11	382785169/1	1	Steering Column Support	
12	125943009/0	4	Screw	
13	325785331/1	1	Right Seat Support	
14	325785333/1	1	Left Seat Support	
15	125943009/0	6	Screw	
16	382785179/0	1	Footboard Support	
17	125943009/0	2	Screw	
18	125943009/0	2	Screw	
19	112155000/0	10	Nut	
20	325500041/1	1	Right Footboard	
21	325500043/1	1	Left Footboard	
22	112735599/0	2	Screw	
23	382785221/0	1	Footboard Support	
24	382785223/0	1	Footboard Support	
25	112293201/0	2	Nut	
26	325820109/1	1	Seat Support	
27	125160048/0	2	Spacer	
28	125430263/0	2	Spring	
30	325820111/1	1	Support	
31	125430264/0	2	Spring	
32	112521350/0	2	Washer	
33	112691400/0	2	Screw	
34	325122002/0	2	Hood	
35	382547061/0	1	Plate	
36	122524970/2	2	Fulcrum Pin	
37	382820151/0	1	Seat Support	
38	112155010/0	2	Self-Locking Nut	
39	118203854/0	2	Screw	
40	125943009/0	12	Screw	
41	325650155/0	1	Support	
42	325650157/0	1	Support	
45	325785379/0	1	Support	
46	112728686/0	2	Screw	

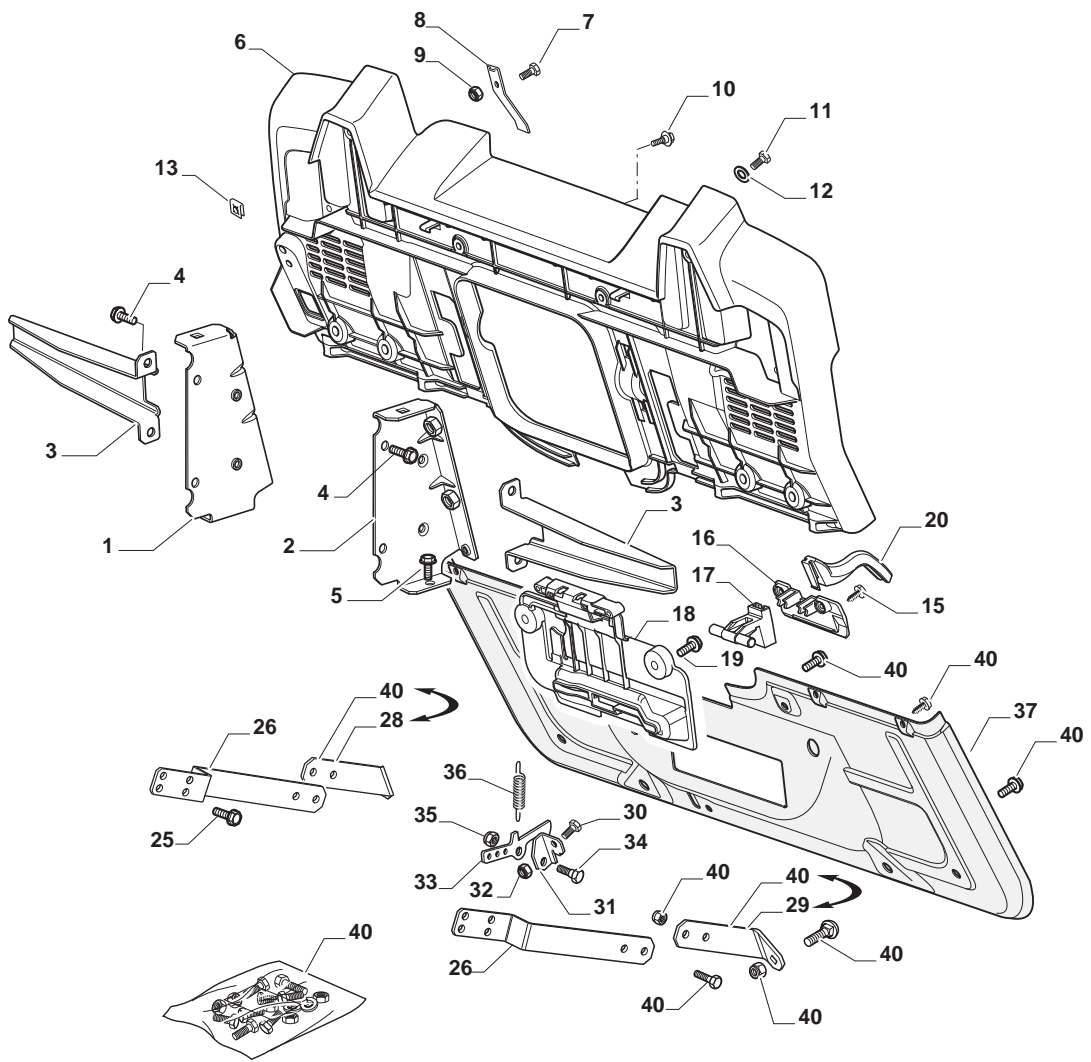

Rear Plate				
POS	CODE	Q.TY	DESCRIPTION	NOTES
1	325774501/0	1	Clamp	
2	325774507/0	1	Clamp	
3	325650163/0	2	Stiffening	
4	125943009/0	8	Screw	
5	125943009/0	2	Screw	
6	325547299/1	1	Rear Plate	
7	112789008/0	1	Screw	
8	127430554/0	1	Spring	
9	112154330/0	1	Low Self-Locking Nut	
10	125943010/0	4	Screw	
11	112789008/0	6	Screw	
12	112523020/0	6	Washer	
13	112437503/0	6	Plate	
15	112728686/0	2	Screw	
16	325109522/0	1	Protection Cover	
17	325318276/0	1	Gearshift	
18	325785400/1	1	Support	
19	125943010/0	2	Screw	
20	325318277/0	1	Lever	
25	112793102/0	4	Screw	
26	325774521/0	2	Clamp	
28	325650151/0	1	Stiffening	
29	325650153/0	1	Stiffening	
30	112789008/0	1	Screw	
31	325755061/0	1	Bracket	
32	112154330/0	1	Low Self-Locking Nut	
33	325774533/0	1	Clamp	
34	125510080/1	1	Pin	
35	112154510/0	1	Nut	
36	125430282/1	1	Hooking Spring	
37	382547071/1	1	Rear Plate, Lower Part	
40	382180121/0	1	Screw	

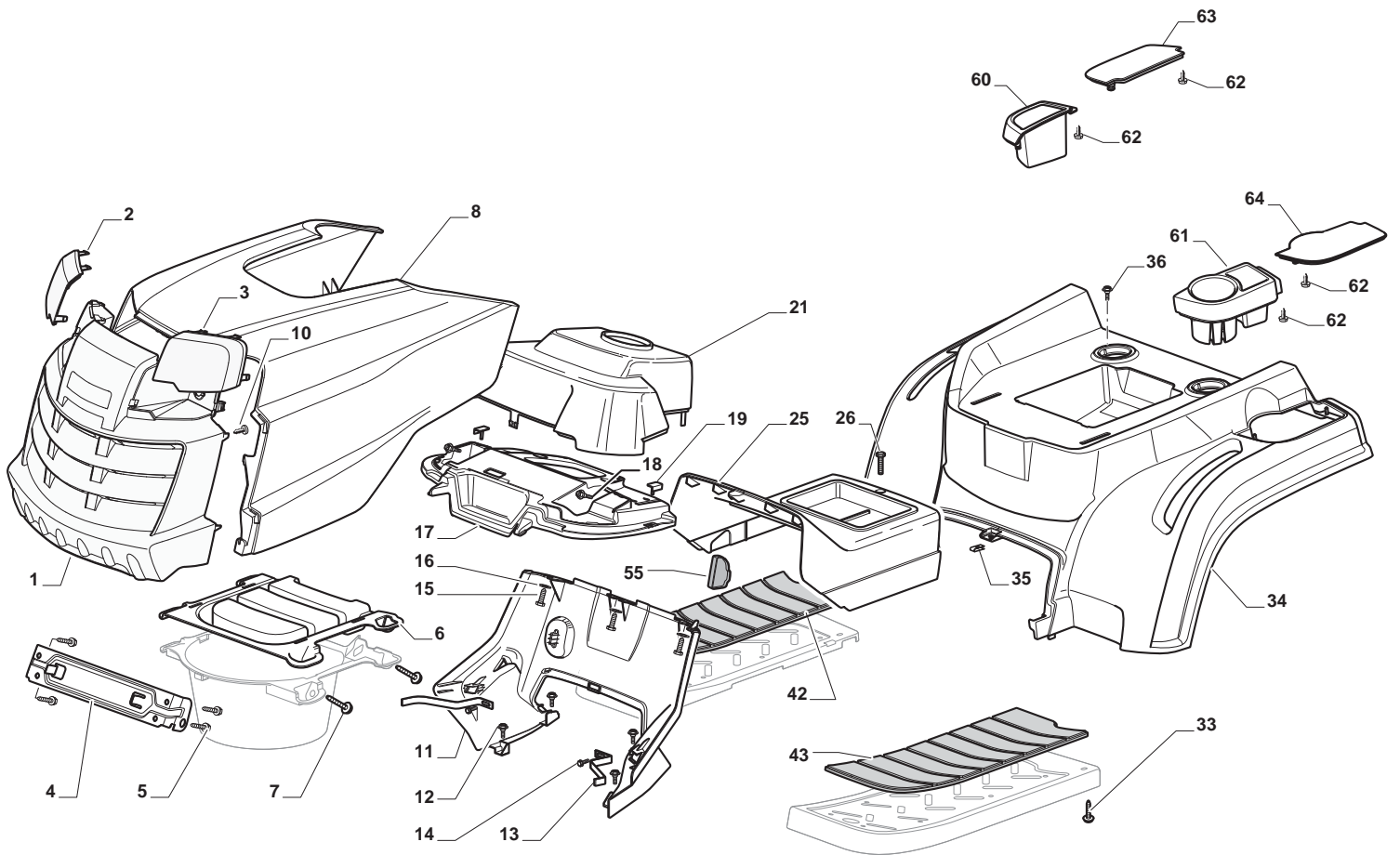

Body				
POS	CODE	Q.TY	DESCRIPTION	NOTES
1	325076914/0	1	Hood, Front	
2	325410903/0	1	Right Grill	
3	325410904/0	1	Left Grill	
4	325785317/0	1	Engine Hood Support	
5	112735403/0	4	Screw	
6	325263302/1	1	Air Intake Grill	
7	112728692/0	4	Screw	
8	325076912/0	1	Engine Hood Yellow	
10	112728686/0	4	Screw	
11	325785298/0	1	Dashboard Support	
12	125943010/0	4	Screw	
13	325270325/0	2	Guide	
14	112735599/0	2	Screw	
15	112735406/0	3	Screw	
16	112523040/0	3	Washer	
17	325120209/0	1	Dashboard	
18	125943010/0	2	Screw	
19	325260003/0	2	Grommet	
21	325120203/0	1	Cover	
25	325110396/1	1	Cover, Yellow	
26	125943010/0	1	Screw	
33	112735406/0	4	Screw	
34	325110438/0	1	Yellow Wheels Cover	
35	112437506/0	1	Plate	
36	125943010/0	2	Screw	
42	325110384/0	1	Right Footboard Cover	
43	325110385/0	1	Left Footboard Cover	
55	325207191/0	1	Plate	
60	325207198/0	1	Cover	
61	325207199/0	1	Cover	
62	112735403/0	4	Screw	
63	325207196/0	1	Cover	
64	325207197/0	1	Cover	

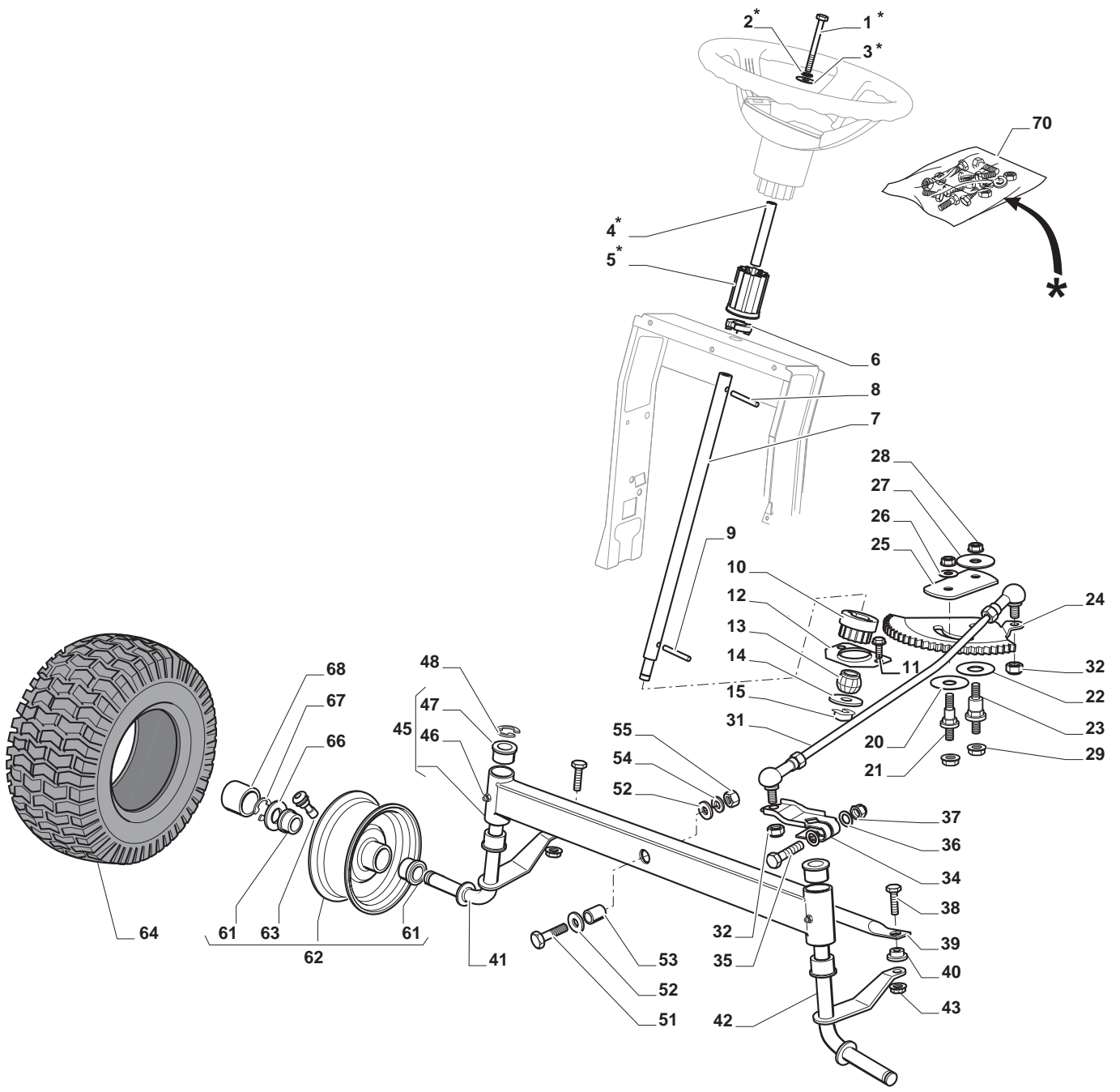

Steering				
POS	CODE	Q.TY	DESCRIPTION	NOTES
1	112692050/0	1	Screw	
2	112540260/0	1	Grower	
3	112523070/0	1	Washer	
4	125160047/0	1	Spacer	
5	325785318/0	1	Support	
6	325038008/0	1	Bushing	
7	125520007/0	1	Steering Column	
8	112620300/0	1	Pin	
9	112622650/0	1	Pin	
10	125570003/0	1	Pinion	
11	127943051/0	2	Screw	
12	325785213/1	1	Support	
13	325743000/0	1	Joint Tc/Junior	
14	112521370/0	1	Washer	
15	112436030/0	1	Plate	
20	322672151/0	1	Antifriction Washer	
21	125510104/0	1	Pin	
22	125670023/0	1	Washer	
23	125510109/0	1	Pin	
24	325735519/0	1	Steering Shaft	
25	325547233/0	1	Plate	
26	112369500/0	1	Elastic Washer	
27	122160400/0	1	Elastic Disk	
28	112155010/0	2	Self-Locking Nut	
29	112155010/0	2	Self-Locking Nut	
31	382000566/2	1	#N/D	
32	112156602/0	2	Nut	
34	325318243/0	1	Lever	
35	112692390/0	1	Screw	
36	112521360/0	2	Washer	
37	112156602/0	1	Nut	
38	125510103/0	2	Pin	
39	325840029/0	1	Tie Rod	
40	325038007/0	2	Bushing	
41	382230373/0	1	Right Stub Axle	
42	382230375/0	1	Left Stub Axle	
43	112155000/0	2	Nut	
45	382034030/0	1	Equalizer With Bush And Lubricator	
46	112379511/0	2	Grease Dispenser	
47	125034002/1	4	Bush	
48	112001010/0	1	Benzing Ring	
51	112692695/0	1	Screw	
52	112523100/0	2	Washer	
53	125160016/0	1	Equalizer Spacer	
54	112587100/0	1	Grower	
55	112295300/0	1	Hexagonal Nut	
61	125122200/2	4	Bearing	
62	182000598/0	2	Rimm	
63	125950000/0	2	Valve	
64	127590066/0	2	Tyre	
66	125670005/1	2	Washer	
67	112001010/0	2	Benzing Ring	
68	322110233/0	2	Hub Cover	
70	382180124/0	1	Screw	

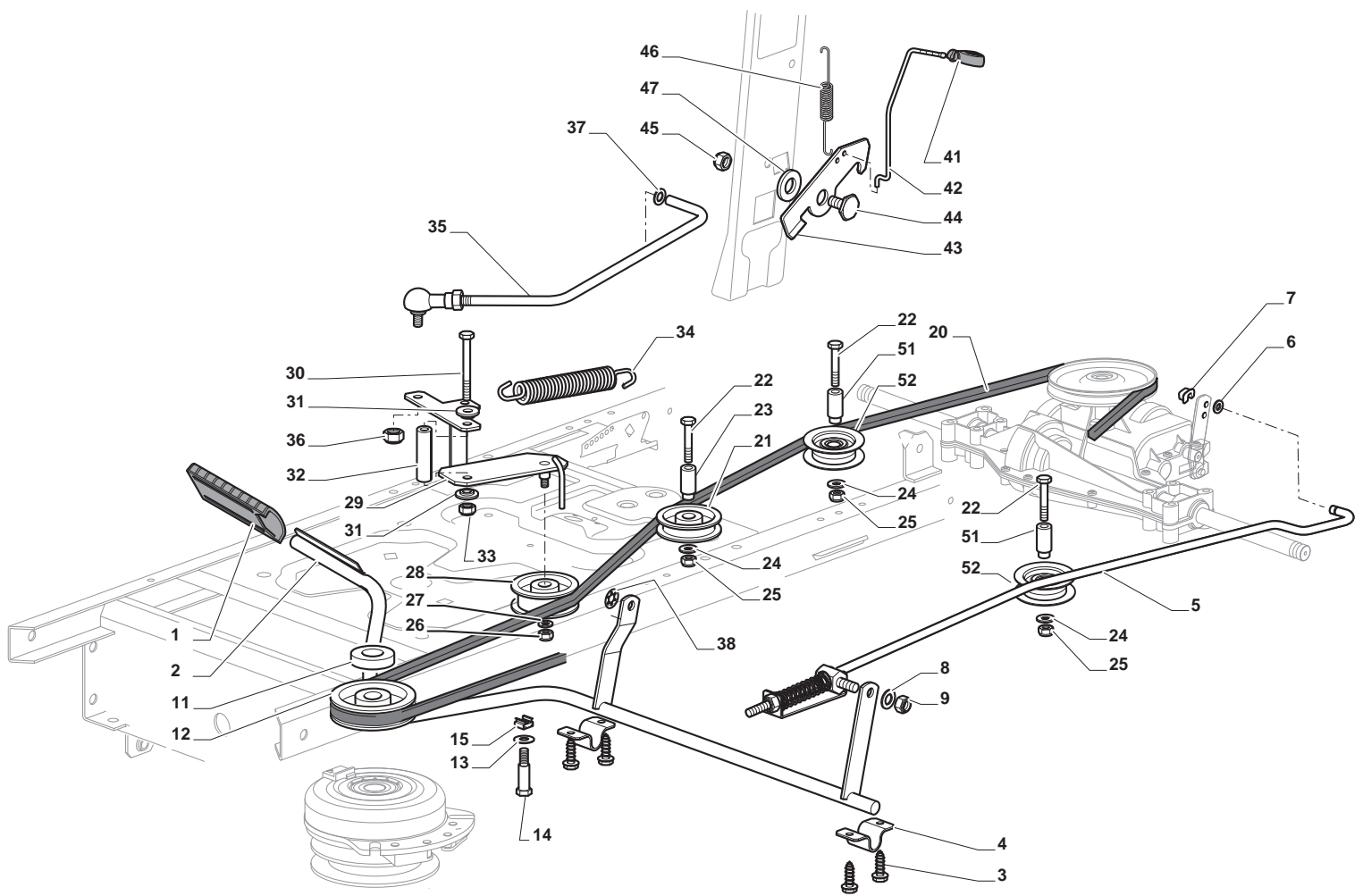

Brake And Gearbox Controls				
POS	CODE	Q.TY	DESCRIPTION	NOTES
1	325110391/0	1	Clamp Cover	
2	382500047/0	1	Pedal	
3	112735599/0	4	Screw	
4	325547231/0	2	Plate	
5	382000568/0	1	Rod	
6	112521350/0	1	Washer	
7	112436050/0	1	Plate	
8	325670011/0	1	Antifriction Washer	
9	112155000/0	1	Nut	
11	125160021/0	1	Spacer	
12	125601567/0	1	Pulley	
13	112524010/0	2	Washer	
14	125580030/0	2	Belt Guide	
15	112360425/0	2	Nut	
20	135062018/0	1	Belt	
21	125601555/0	1	Pulley	
22	112691400/0	3	Screw	
23	125160051/0	1	Spacer	
24	112523060/0	3	Washer	
25	112155000/0	3	Nut	
26	112155000/0	1	Nut	
27	112523060/0	1	Washer	
28	125601554/0	1	Pulley	
29	382318235/1	1	Lever	
30	112691600/0	1	Screw	
31	125038002/1	2	Bush	
32	125160027/0	1	Spacer	
33	112155000/0	1	Nut	
34	125430262/0	1	Spring	
35	382820016/1	1	Tie Rod Ass.Y	
36	112293201/0	1	Nut	
37	124487997/0	1	Cotter Pin	
38	112604899/0	1	Crown Fastener	
41	325394534/0	1	Knob	
42	125033083/0	1	Rod	
43	325253011/1	1	Hook	
44	122524970/2	1	Fulcrum Pin	
45	112155000/0	1	Nut	
46	125430213/0	1	Spring	
47	112523060/0	1	Washer	
51	125160068/0	2	Spacer	
52	125601592/0	2	Pulley	

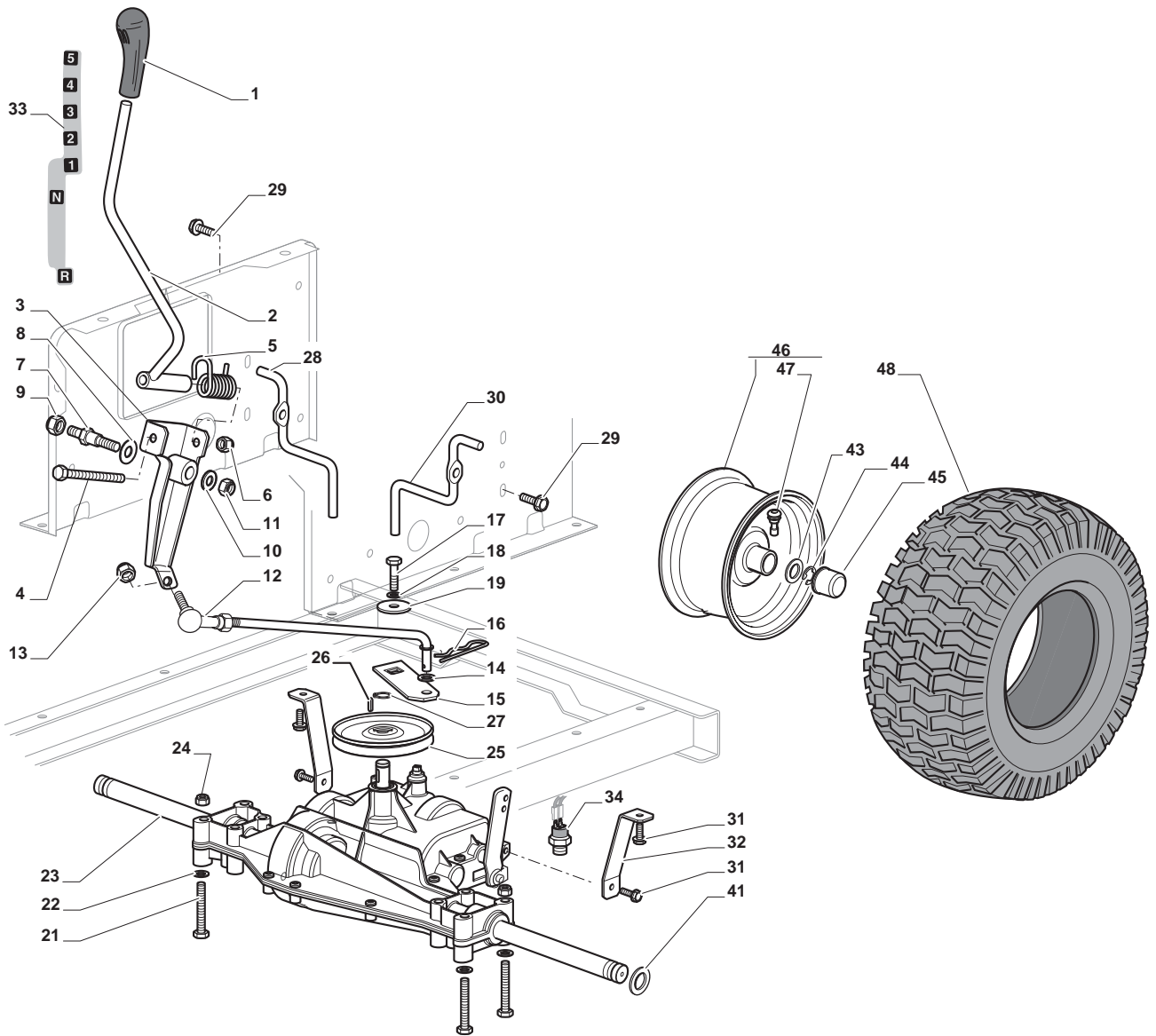

Transmission				
POS	CODE	Q.TY	DESCRIPTION	NOTES
1	325394532/0	1	Knob	
2	382318257/0	1	Lever	
3	382774259/0	1	Clamp	
4	112692050/0	1	Screw	
5	125430226/0	1	Spring	
6	112155000/0	1	Nut	
7	125510035/0	1	Pin	
8	322672151/0	1	Antifriction Washer	
9	112155010/0	1	Self-Locking Nut	
10	112523060/0	1	Washer	
11	112155010/0	1	Self-Locking Nut	
12	382000649/0	1	Connecting Rod	
13	112154210/0	1	Self-Locking Nut	
14	112521340/0	1	Washer	
15	325318235/0	1	Lever	
16	112141418/0	1	Cotter Pin	
17	112735520/0	1	Screw	
18	112540040/0	1	Washer	
19	322680009/0	1	Washer	
21	112691600/0	4	Screw	
22	112521350/0	4	Washer	
23	118400910/2	1	Transmission	
24	112155000/0	4	Nut	
25	182601509/0	1	Pulley	
26	112139430/0	1	Key	
27	112608950/0	1	Seeger	
28	125270329/0	1	Belt Guide	
29	112735599/0	2	Screw	
30	125270330/0	1	Belt Guide	
31	125943009/0	4	Screw	
32	325785315/0	2	Support	
33	114366141/0	1	Label	
34	119410608/1	1	Micro Lever	
43	125670005/1	6	Washer	
44	112001010/0	2	Benzing Ring	
45	322110233/0	2	Hub Cover	
46	382000597/0	2	Rimm	
47	125950000/0	2	Valve	
48	125590015/0	2	Tyre	

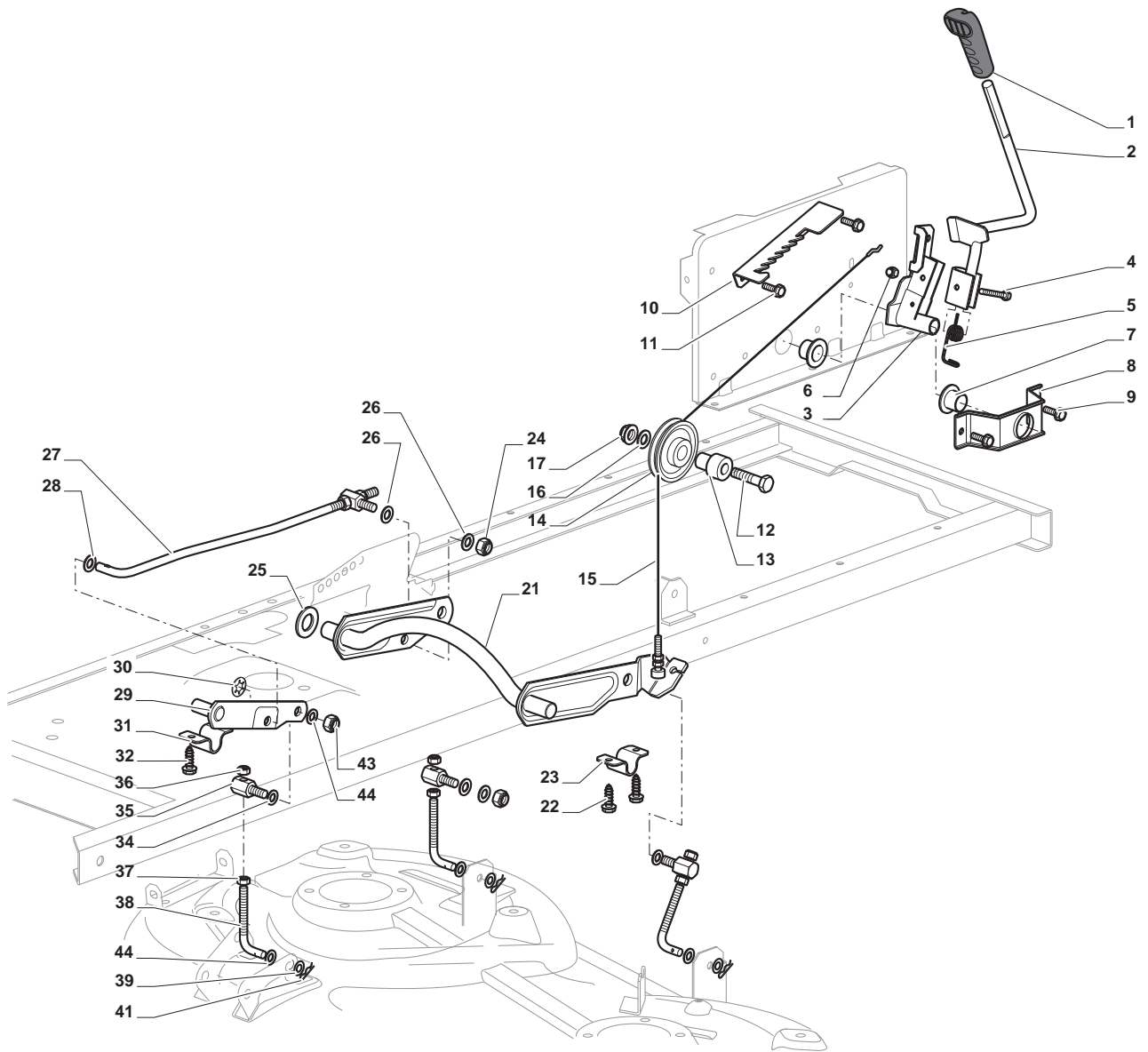

Cutting Plate Lifting				
POS	CODE	Q.TY	DESCRIPTION	NOTES
1	325394533/0	1	Knob	
2	382318255/0	1	Lever	
3	382318231/0	1	Axle	
4	112674700/0	1	Screw	
5	125430261/0	1	Spring	
6	112154510/0	1	Nut	
7	325038006/0	2	Bushing	
8	325785297/0	1	Support	
9	125943009/0	2	Screw	
10	325735515/0	1	Steering Shaft	
11	125943009/0	2	Screw	
12	112793701/0	1	Screw	
13	125040636/1	1	Bushing	
14	125601579/0	1	Pulley	
15	382004620/0	1	Wire	
16	112523060/0	1	Washer	
17	112293201/0	1	Nut	
21	382318253/0	1	Axle	
22	112735599/0	4	Screw	
23	325547231/0	2	Plate	
24	112155000/0	1	Nut	
25	112521390/0	2	Washer	
26	325670011/0	2	Antifriction Washer	
27	382000569/1	1	Connecting Rod	
28	112521350/0	1	Washer	
29	382318237/0	1	Axle	
30	112604899/0	1	Crown Fastener	
31	325547231/0	1	Plate	
32	112735599/0	2	Screw	
34	325670008/1	3	Washer	
35	125510107/1	3	Pin	
36	112156602/0	3	Nut	
37	112295200/0	3	Hexagonal Nut	
38	125840012/0	3	Tie Rod	
39	112523060/0	3	Washer	
41	124487998/0	3	Cotter Pin	
43	112156602/0	3	Nut	
44	325670008/1	6	Washer	

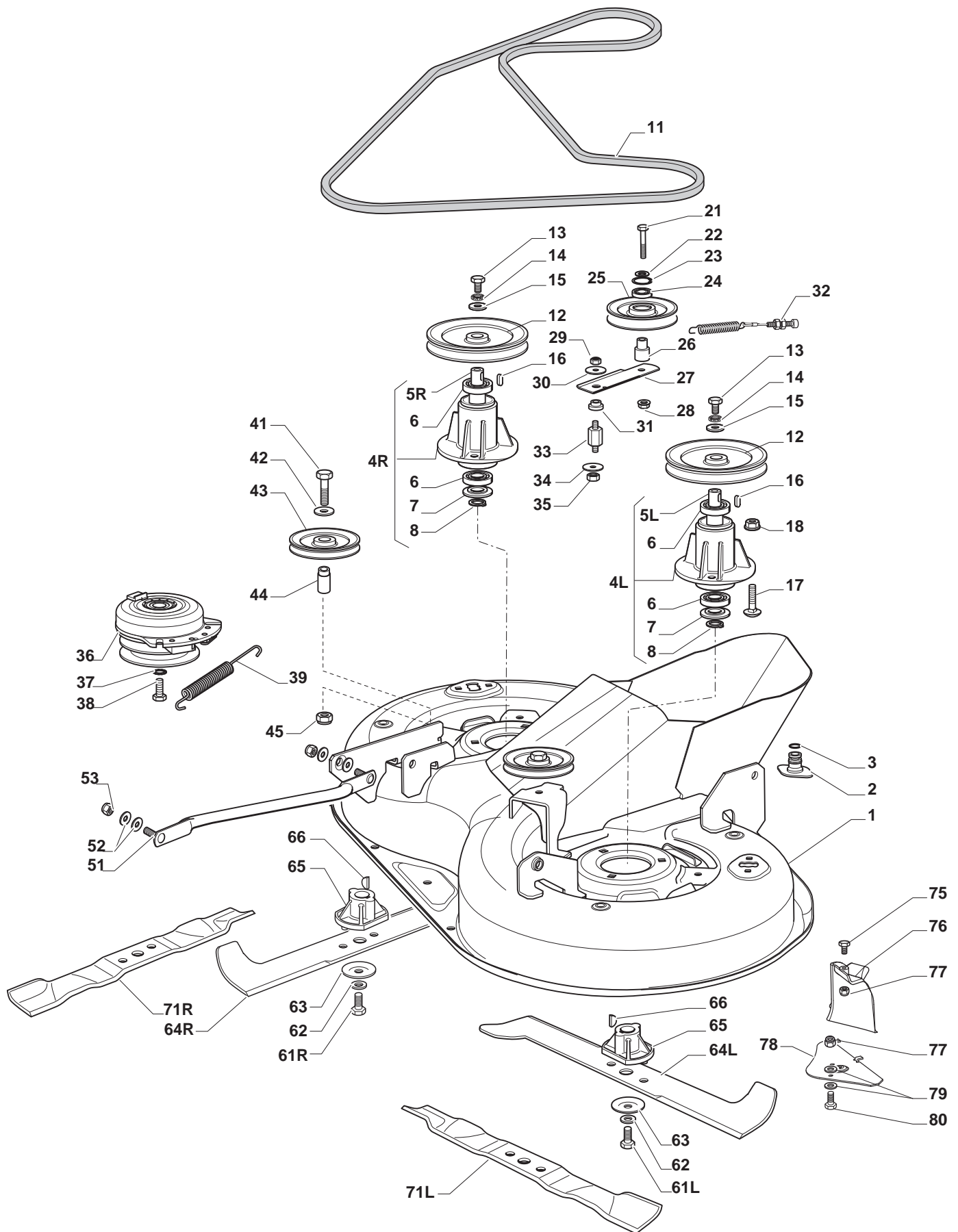

Cutting Deck				
POS	CODE	Q.TY	DESCRIPTION	NOTES
1	382564114/0	1	Cutting Plate Black	
2	325033086/0	2	Water Hose Connection	
3	119035000/0	2	O.R. Ring	
4R	382207205/0	1	Flange Assy	
4L	382207206/0	1	Flange Assy	
5L	125020804/0	1	Shaft	
5R	125020805/0	1	Shaft	
6	119216047/0	4	Bearing	
7	325160501/0	2	Dust Cover Disc	
8	112609260/0	2	Seeger	
11	135061508/0	1	Belt	
12	125601585/1	2	Pulley	
13	112793102/0	2	Screw	
14	112540260/0	2	Grower	
15	125670007/0	2	Washer	
16	112139480/0	2	Feather	
17	112818700/0	6	Screw	
18	112154210/0	6	Self-Locking Nut	
21	112691400/0	1	Screw	
22	112524010/0	1	Washer	
23	112610800/0	1	Snap Ring	
24	119216048/0	1	Bearing	
25	125601595/0	1	Pulley	
26	125160052/0	1	Spacer	
27	325318289/0	1	Lever	
28	112293201/0	1	Nut	
29	112155020/0	1	Self-Locking Nut	
30	125670022/0	1	Washer	
31	125040635/0	1	Bushing	
32	382004618/0	1	Wire	
33	125160049/0	1	Spacer	
34	112523080/0	1	Washer	
35	112156602/0	1	Nut	
36	118399069/0	1	Clutch Assy	
37	112543000/0	1	Washer	
38	112737320/0	1	Screw	
39	125430277/0	1	Spring	
41	112691115/0	2	Screw	
42	112523060/0	2	Washer	
43	125601555/0	2	Pulley	
44	125160069/0	2	Spacer	
45	112155000/0	2	Nut	
51	382000565/0	2	Equalizer Rod	
52	325670008/1	8	Washer	
53	112156602/0	4	Nut	
61L	112735694/0	1	Screw	
61R	112735695/1	1	Screw	
62	112523080/0	2	Washer	
63	122160400/0	2	Elastic Disc	
64R	182004358/0	1	Right Blade, Winged	
64L	182004359/0	1	Left Blade, Winged	
65	125463200/0	2	Blade Hub	
66	112139100/0	2	Key	
71R	182004360/0	1	Right Mulching Blade	
71L	182004361/0	1	Left Mulching Blade	
75	112791213/1	3	Screw	
76	325140108/0	1	Deflector	
77	112154510/0	4	Nut	
78	325785418/0	1	Support	
79	112523040/0	4	Washer	
80	112790781/0	1	Screw	

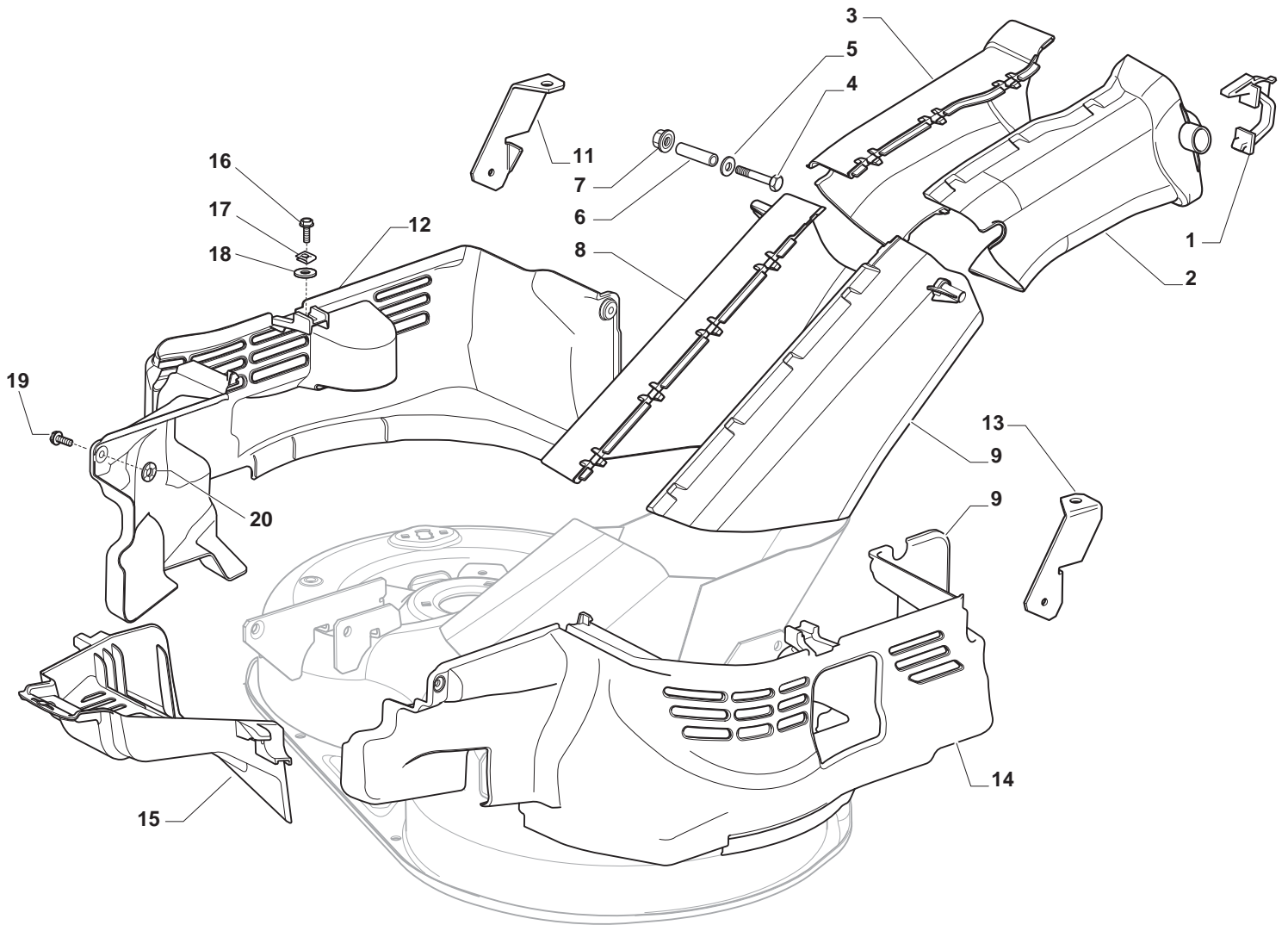

Guards				
POS	CODE	Q.TY	DESCRIPTION	NOTES
1	325774499/0	2	Clamp	
2	325108056/0	1	Conveyor	
3	325108057/0	1	Conveyor	
4	112792425/0	2	Screw	
5	112521330/0	2	Washer	
6	125160071/0	2	Spacer	
7	112154510/0	2	Nut	
8	325108064/0	1	Conveyor	
9	325108065/0	1	Conveyor	
11	325774527/0	1	Clamp	
12	325060164/0	1	Case	
13	325774529/0	1	Clamp	
14	325060165/0	1	Case	
15	325060166/0	1	Guard	
16	112789008/0	2	Screw	
17	112437503/0	2	Plate	
18	112521320/0	2	Washer	
19	125943011/0	4	Screw	
20	112604899/0	4	Crown Fastener	

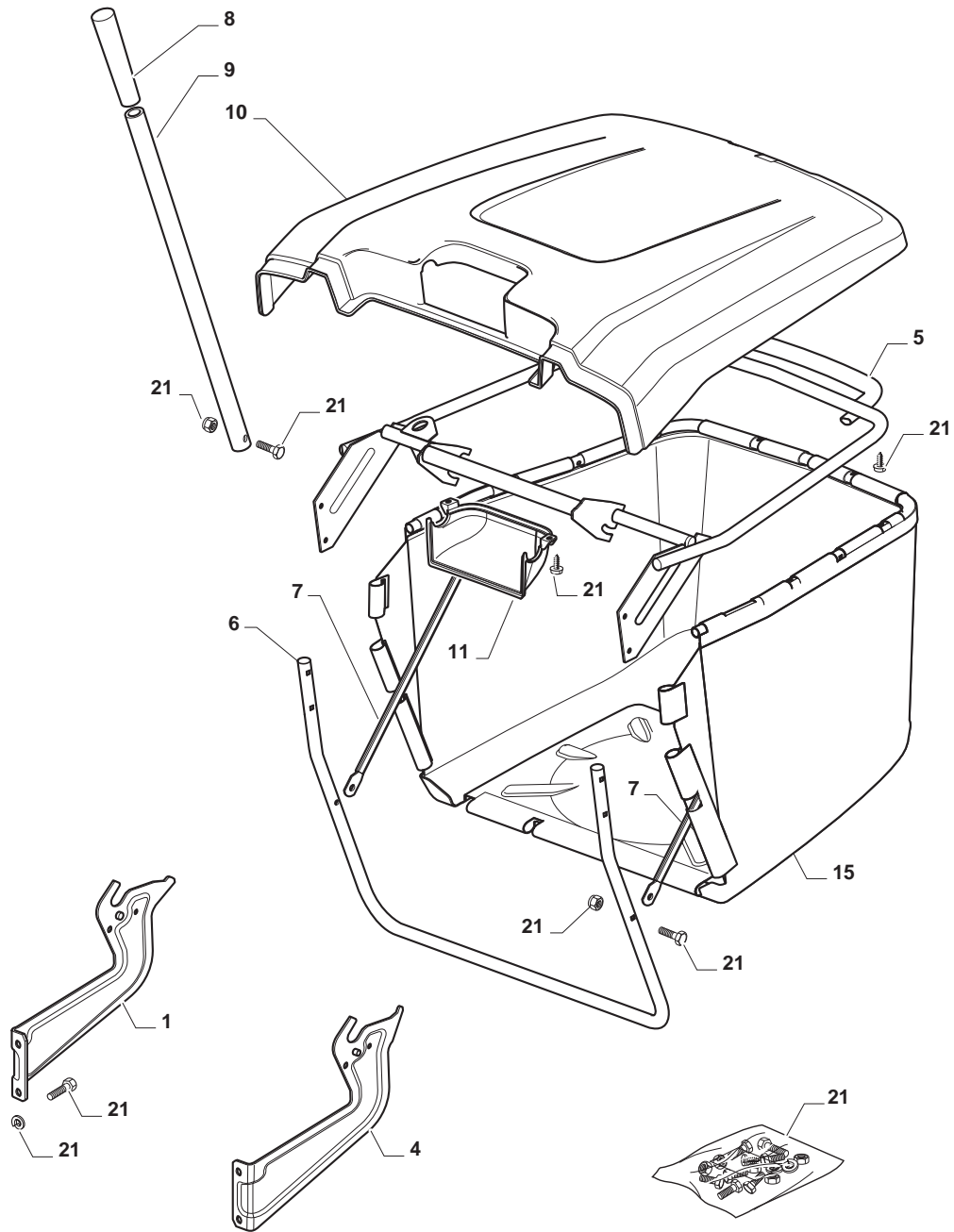

Grasscatcher				
POS	CODE	Q.TY	DESCRIPTION	NOTES
1	325785377/0	1	Support	
4	325785383/0	1	Support	
5	382800139/0	1	Upper Frame	
6	382800141/0	1	Front Frame	
7	325650149/0	2	Stiffening	
8	125394508/0	1	Knob	
9	325869087/0	1	Rod	
10	325110439/0	1	Yellow Grass-Catcher Cover	
15	182105947/0	1	Grasscatcher	
21	382180123/0	1	Screw	

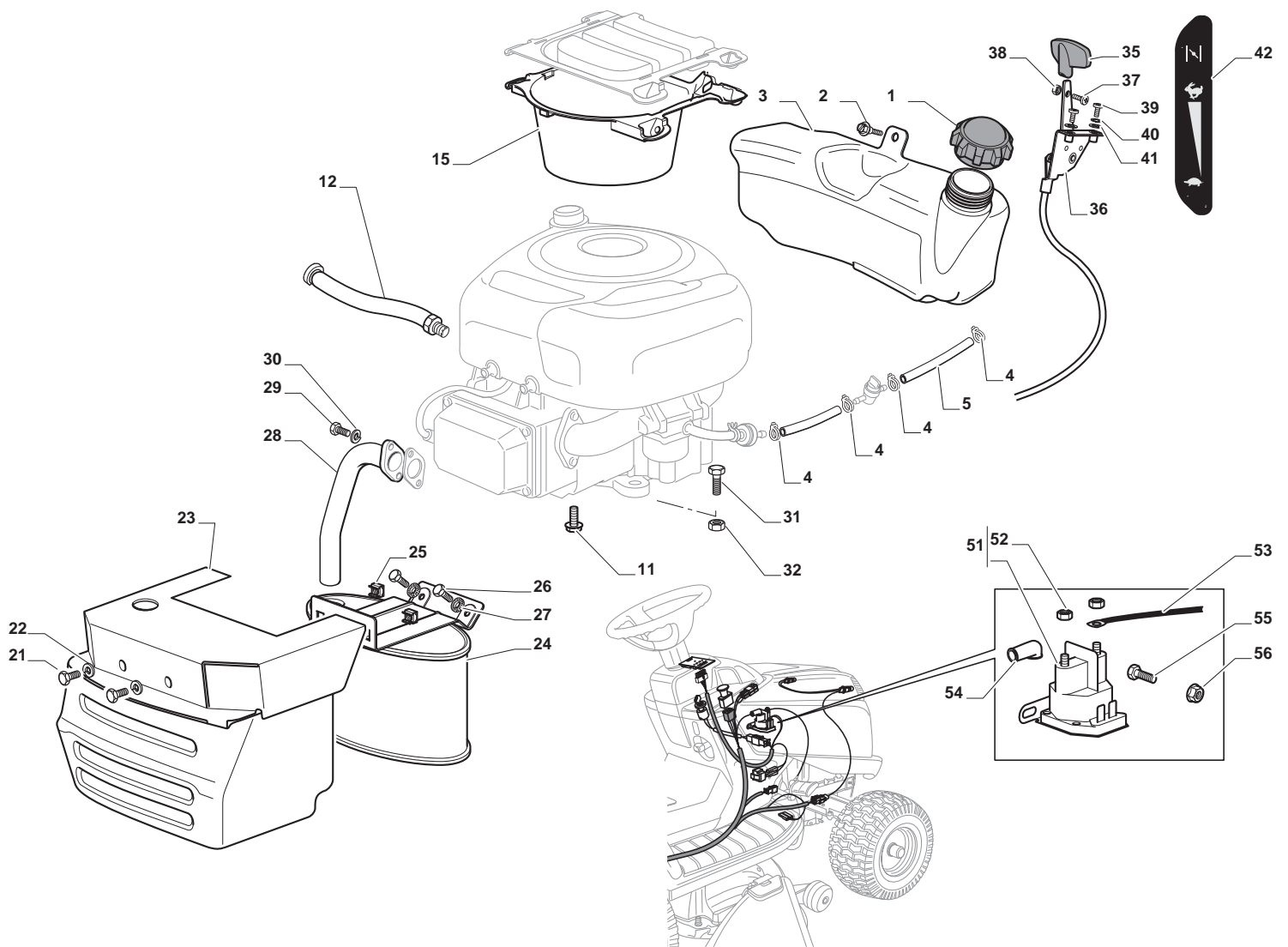

Engine B&S 13,5 hp				
POS	CODE	Q.TY	DESCRIPTION	NOTES
1	125795001/1	1	Fuel Cap	
2	125943010/0	4	Screw	
3	325735126/0	1	Tank	
4	118375051/1	4	Fair Led	
5	325869057/0	1	Connecting Tube	
11	112735108/1	3	Screw	
12	1134-5827-01	1	Oil Drain Assy	
15	325108044/1	1	Conveyor	
21	112792611/0	2	Screw	
22	112540260/0	2	Grower	
23	382598047/0	1	Muffler Protection	
24	182750010/0	1	Muffler	
25	112360425/0	2	Nut	
26	112792611/0	2	Screw	
27	112540260/0	2	Grower	
28	118738224/0	1	Exhaust Conn. Tube	
29	112737450/0	2	Screw	
30	112540260/0	2	Grower	
31	112691115/0	1	Screw	
32	112154210/0	3	Self-Locking Nut	
35	325394531/0	1	Knob	
36	182000216/0	1	Accelerator	
37	112726389/0	1	Screw	
38	112290800/0	1	Hexagonal Nut	
39	112726389/0	2	Screw	
40	112540020/0	2	Washer	
41	112521310/0	2	Washer	
42	114363697/0	1	Label	
51	118736111/0	1	Starter Relay	
52	112360352/0	2	Nut	
53	125065002/0	1	Cable	
54	118564864/1	1	Protection	
55	112790781/0	1	Screw	
56	112154510/0	2	Nut	

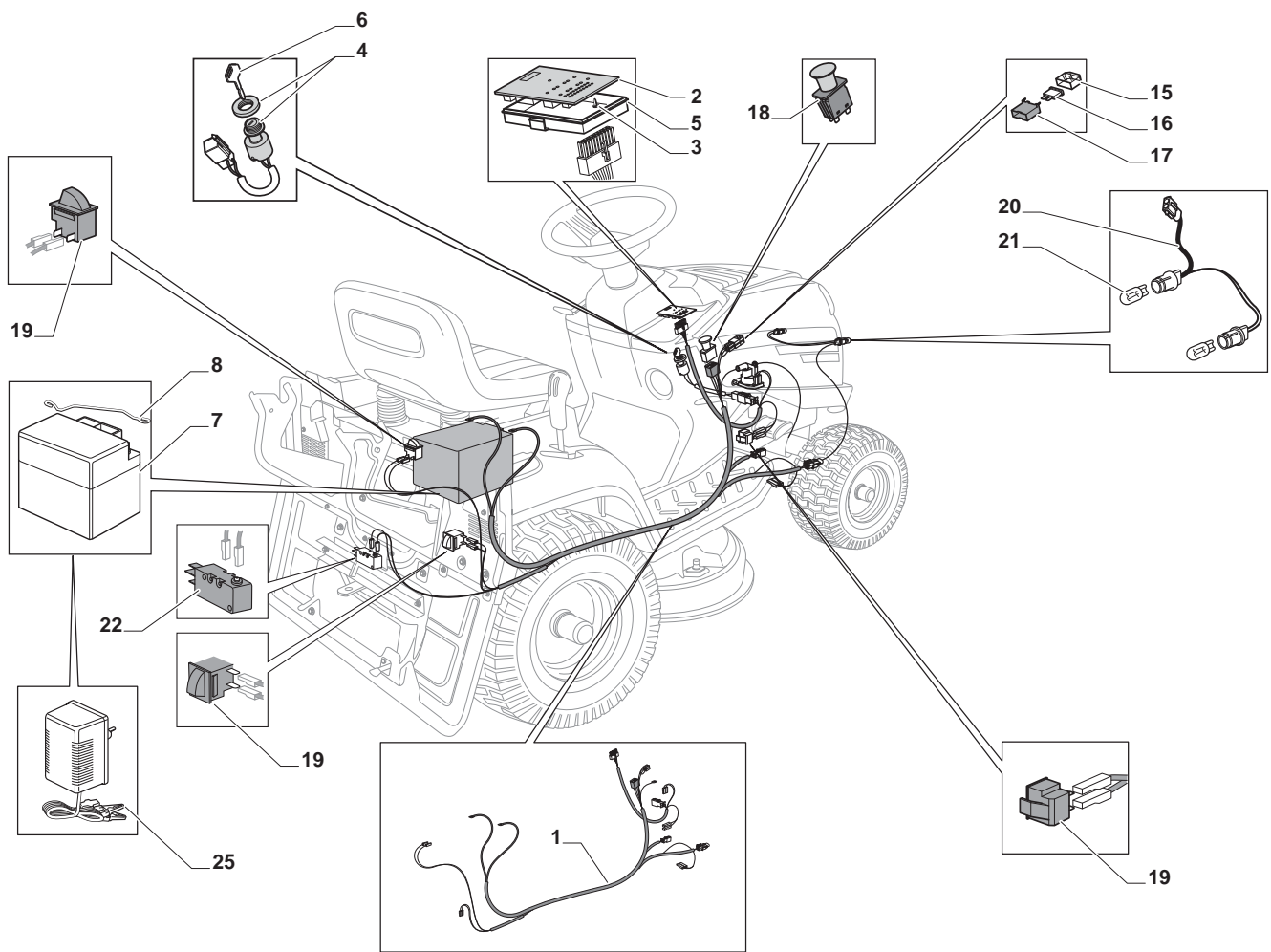

Electrical Parts				
POS	CODE	Q.TY	DESCRIPTION	NOTES
1	182040183/0	1	Cables Ass.Y	
2	125722437/0	1	Electronic Card	
3	112735101/0	3	Screw	
4	118450075/0	1	Starting Switch	
5	325600090/0	1	Card Protection	
6	118210023/0	1	Starting Key	
7	118120002/1	1	Battery	
8	125430265/1	1	Spring	
15	133215000/0	2	Cover	
16	133340036/0	1	Fuse 25 A	
16	133340040/0	1	Lamellar Fusible 10A	
17	133500007/0	2	Fuse Carrier	
18	118450074/0	1	Clutch Switch	
19	119410613/0	3	Micro Switch	
20	182040186/0	1	Cable	
21	118459100/0	2	Lamp For Lights	
22	119410605/1	1	Micro Switch	
25	182180090/0	1	Battery Charger	UE Plag
25	182180091/0	1	Battery Charger (Uk)	UK Plag

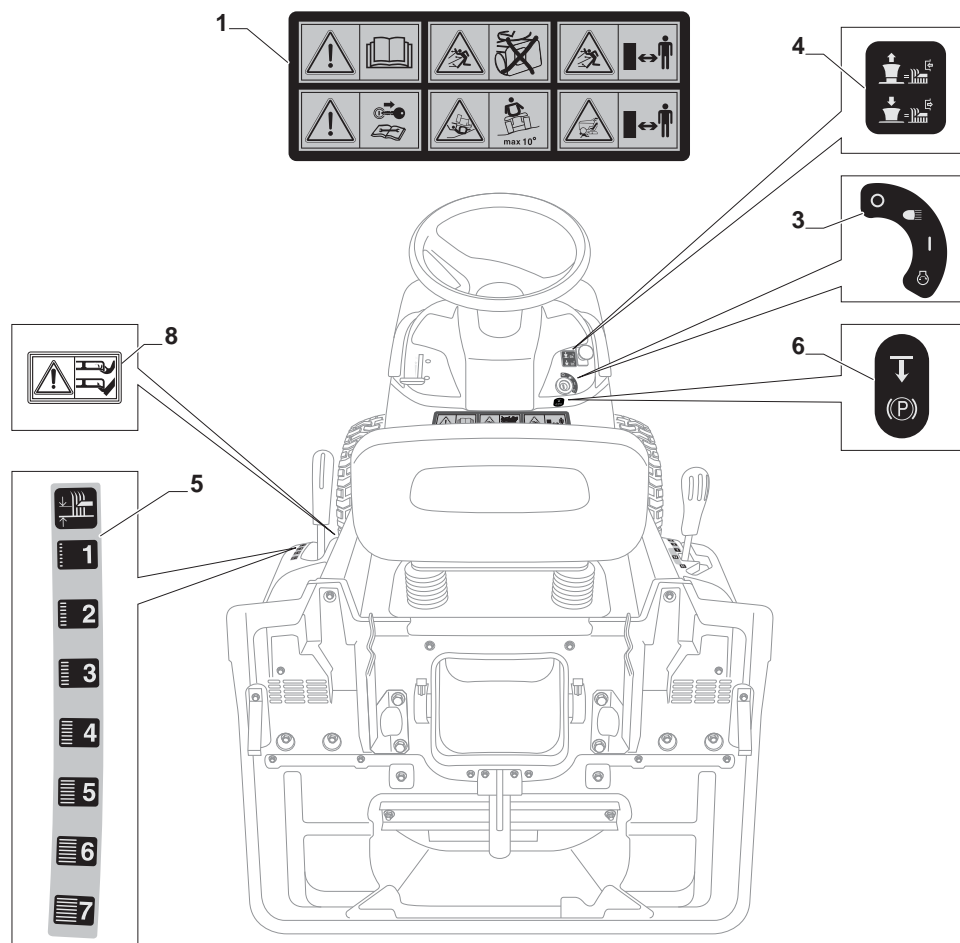

Labels				
POS	CODE	Q.TY	DESCRIPTION	NOTES
1	114361553/1	1	Cutting Plate Black	
3	114363699/0	1	Cutting Plate Red	
4	114361438/0	1	Cutting Plate Yellow	
5	114363701/0	1	Left Flange Ass.Y	
6	114363700/0	1	Shaft	
8	114356699/1	1	Bearing	

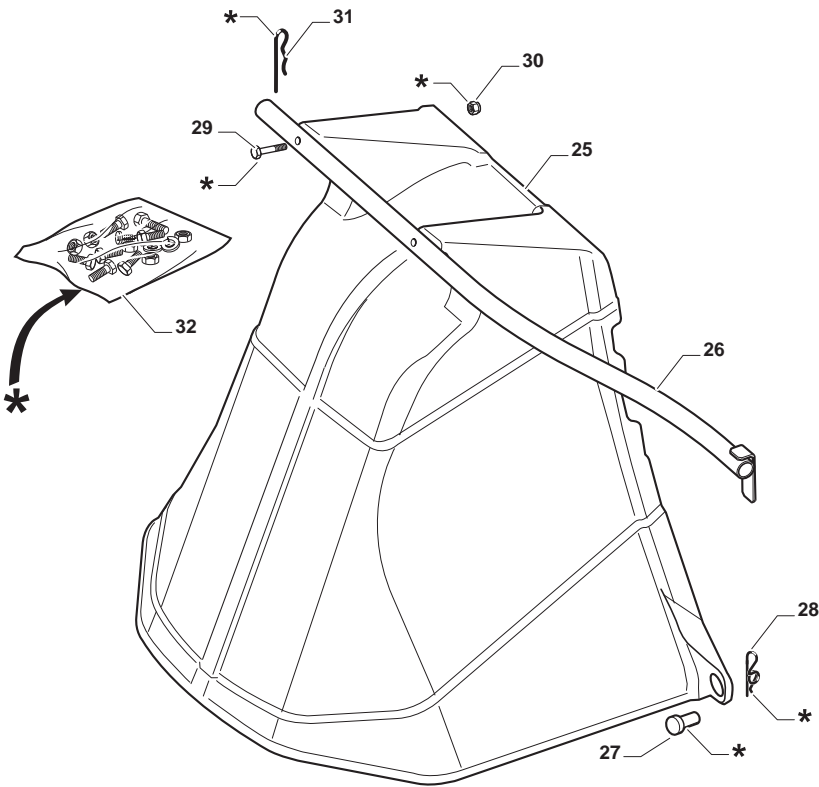
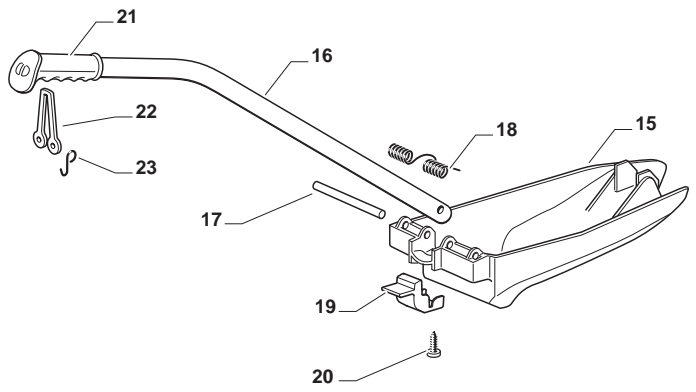
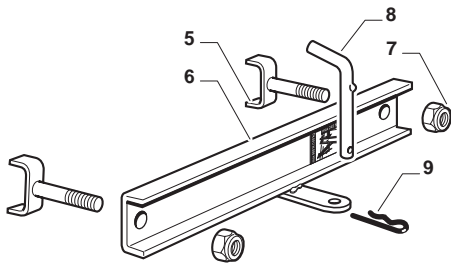
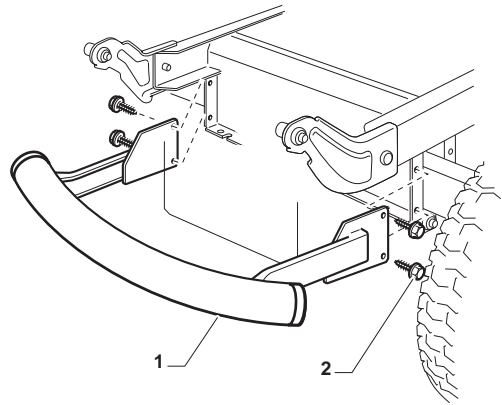

Optionals On Request				
POS	CODE	Q.TY	DESCRIPTION	NOTES
1	382869038/0	1	Muffler Protection	
2	125943008/0	4	Screw	
5	382650211/0	2	Stiffening	
6	382033119/0	1	Tow Bar Assy	
7	112155000/0	2	Nut	
8	125510021/1	1	Hitch Pin	
9	124487999/0	1	Spring Pin	
15	325140104/0	1	Deflector	
16	325394021/0	1	Handle	
17	125510077/0	1	Pin	
18	125430245/0	1	Spring	
19	325547320/0	1	Plate	
20	112735403/0	1	Screw	
21	325280000/1	1	Handgrip	
22	125840011/1	1	Tie Rod	
23	125253004/0	2	Mulch.Kit Fixing Hook	
25	325600093/0	1	Ejection Guard	
26	382869044/0	1	Support	
27	125510022/1	2	Pin	
28	124487998/0	2	Cotter Pin	
29	112689515/0	2	Screw	
30	112154510/0	2	Nut	
31	124487999/0	1	Spring Pin	
32	382180028/0	1	Screws Outfit	

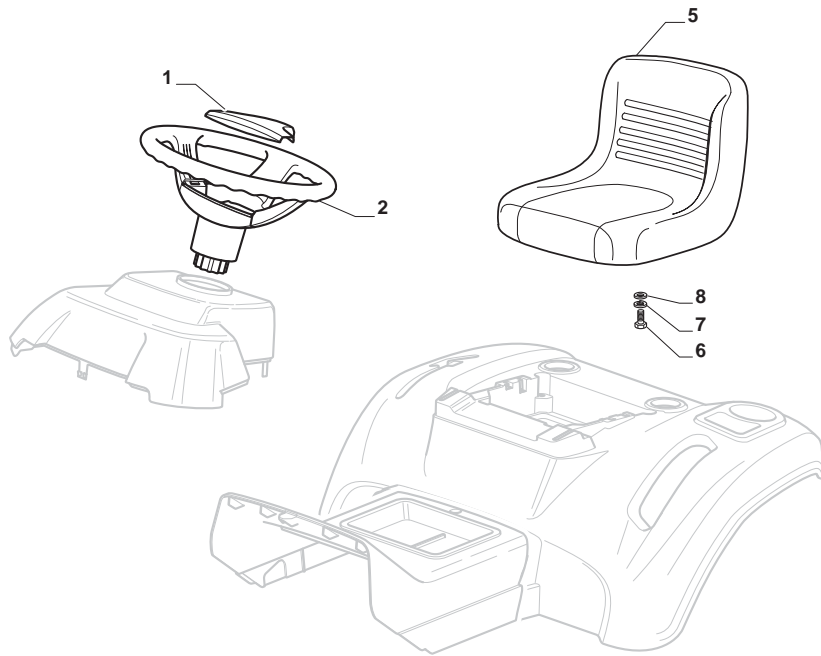

Seat & Steering Wheel				
POS	CODE	Q.TY	DESCRIPTION	NOTES
1	325580504/0	1	Steering Plate	
2	325961219/0	1	Steering Wheel	
5	125722471/0	1	Seat	
6	112792611/0	4	Screw	
7	112540260/0	4	Grower	
8	112523060/0	4	Washer	